

SECTION A-A
SCALE 1 : 6

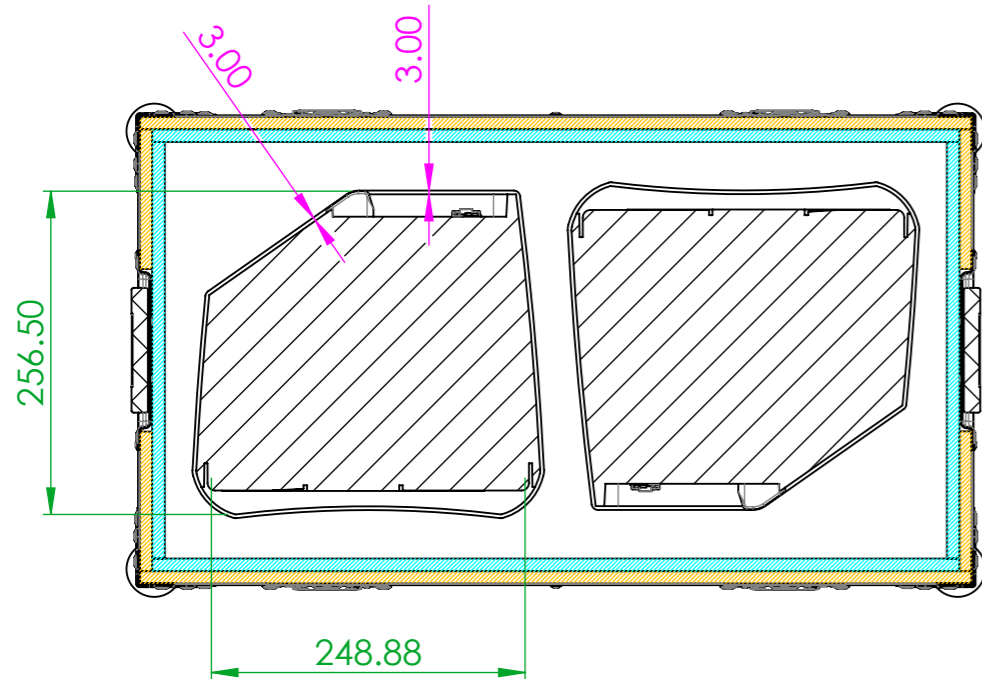

SECTION B-B
SCALE 1 : 6

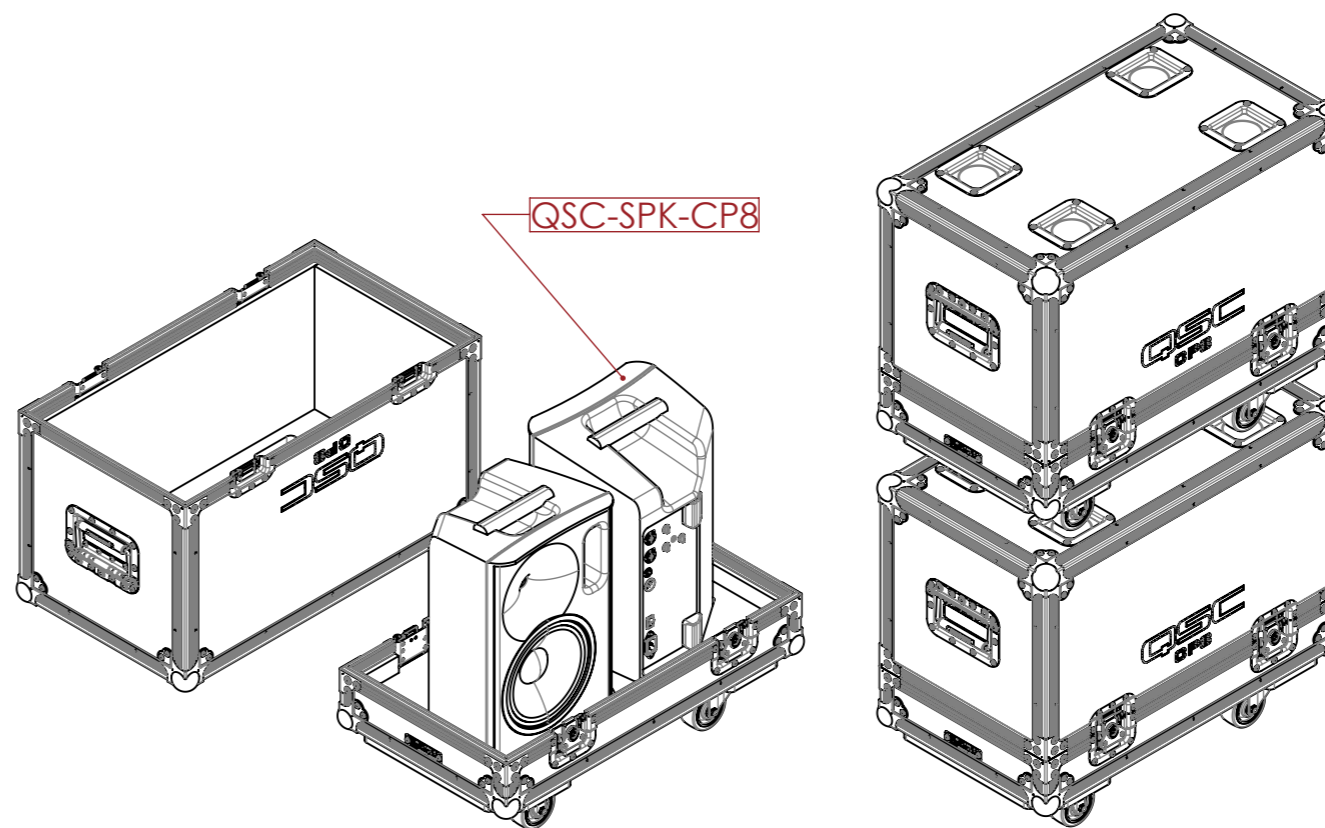

NOTES:
UNLESS SPECIFIED IN THE DRAWING,
ALL PRODUCTS DISPLAYED IN THIS
DRAWING OTHER THAN THE CASE
ITSELF IS NOT PART OF OUR PRODUCT
OFFERING.

- CARPET
- EVA FOAM
- PLYWOOD
- EXTERNAL DIMENSIONS
- INTERNAL DIMENSIONS
- TOLERANCES
- EQUIPMENT DIMENSIONS
- EPE 25 FOAM

REV	DESCRIPTION	DATE
0	ORIGINAL ISSUE	10/31/2022

ESTIMATED WEIGHT (CASE ONLY):
19.05 KG

ITEM CODE:
SPK-QSC-CP8

DRAWN BY: HA CHECKED BY: AS

SCALE:
NTS



MAIL : sales@armorcases.com.au
WEB : www.armorcases.com.au